

DORSI 2D2S

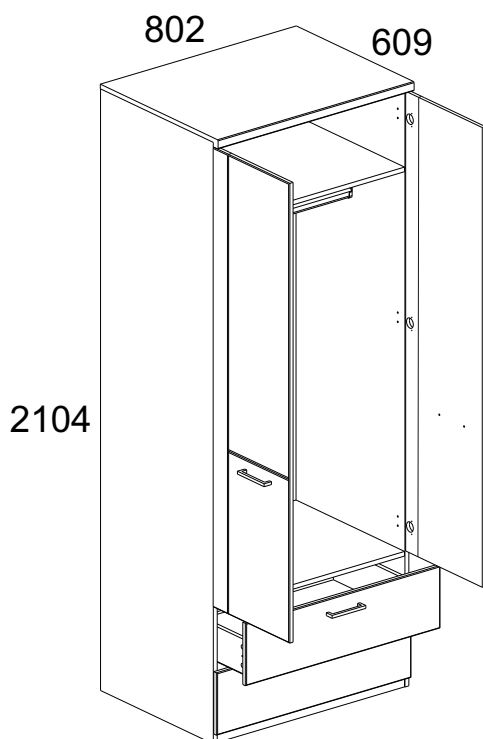

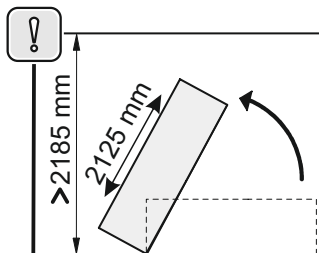

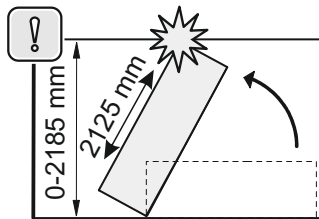

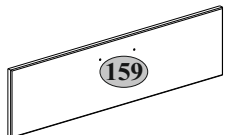
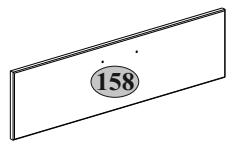
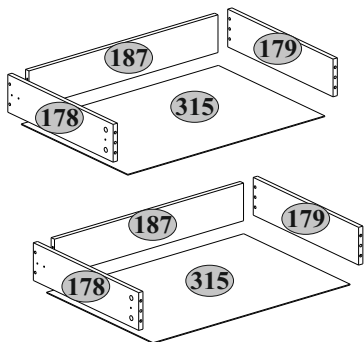
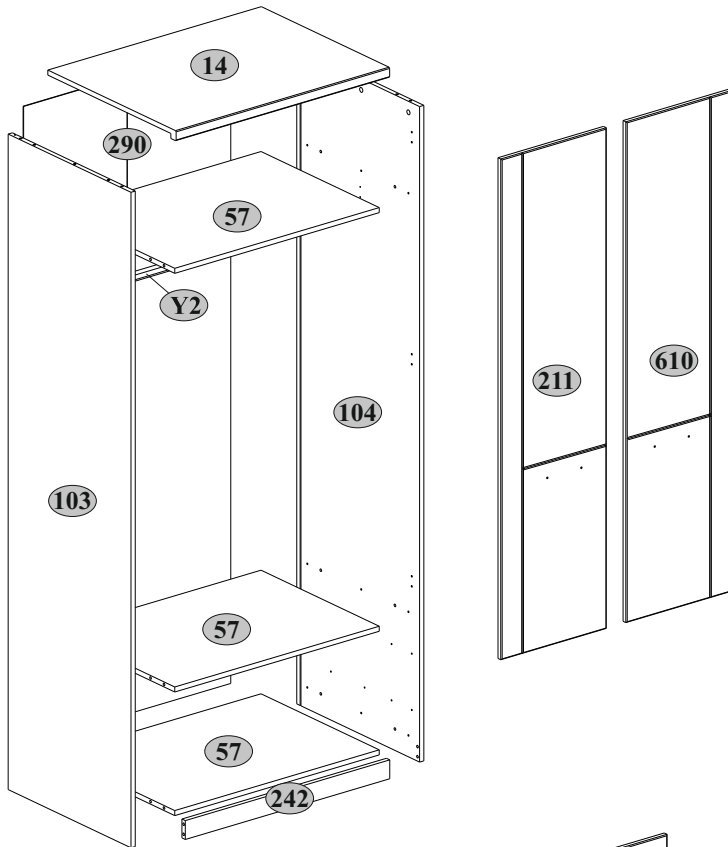

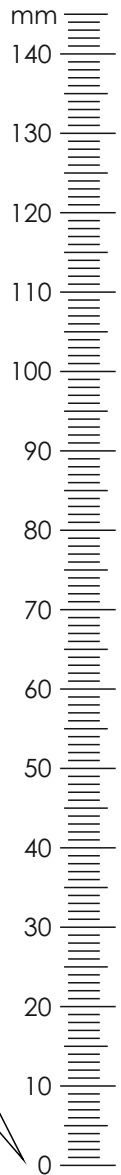



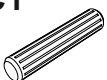
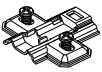
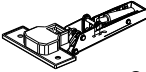



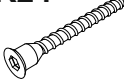

	L, mm	B, mm	H, mm	Q	
14	802	609	32	1	1/3
57	768	563	16	3	1/3
103	2084	583	16	1	2/3
104	2084	583	16	1	2/3
158	796	216	16	1	3/3
159	796	216	16	1	3/3
178	500	120	16	2	1/3
179	500	120	16	2	1/3
187	710	120	16	2	3/3
211	396	1592	16	1	3/3
242	768	60	16	1	1/3
290	2030	389	2,5	2	2/3
315	740	505	2,5	2	1/3
610	396	1592	16	1	3/3
Y2	761				3/3





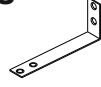

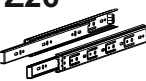
A1  7x34 32	A2  Ø15x12 32	B5  10x50 1	C1  8x35 28
D1-1  6	E1-1  6	H58  4	I  S4 1
L2  500 2	N1  4	R3  3x20 28	R23  6,3x13 12
R24  7x50 8	R27  5,0x13 28	R32  4x27 8	R102  3,5x16 22
S1  18	S5  Ø18 20	U  130x35x15 1	Y1  2
Z26  500 2			

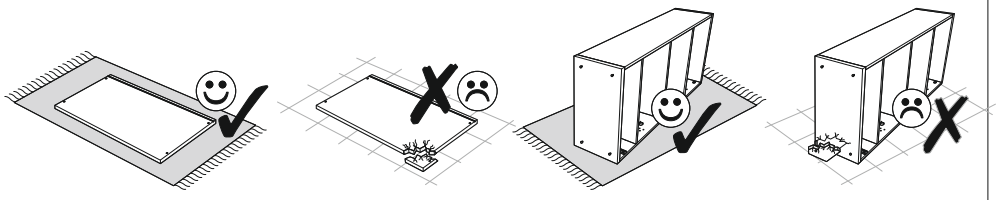
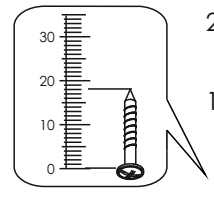
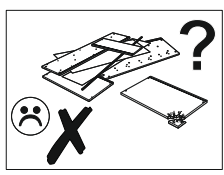
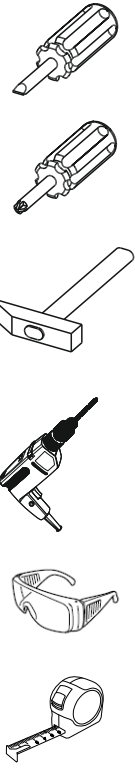

1**A1**

7x34

18

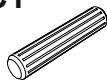
C1

8x35

4

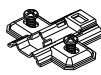
D1-1

6

R23

6,3x13

12

R27

5,0x13

16

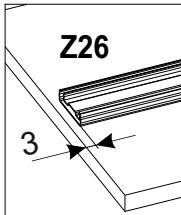
Z26**R102**

3,5x16

4

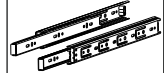
Y1**Z26**

2

500

2

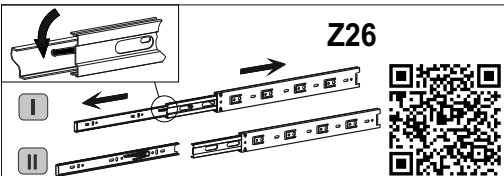
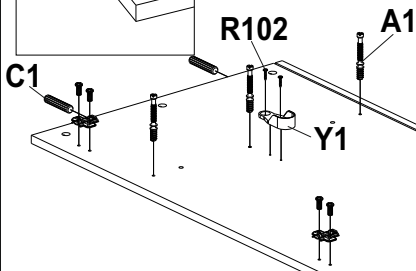
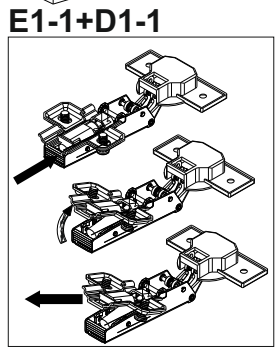
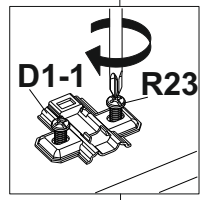
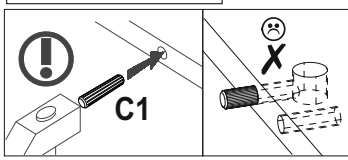
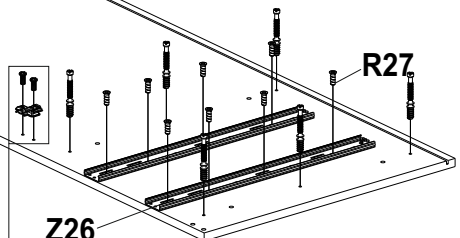
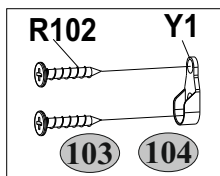
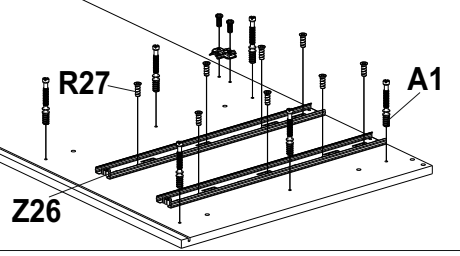
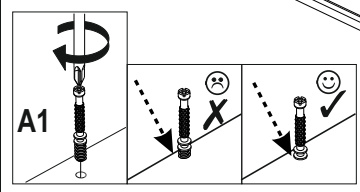
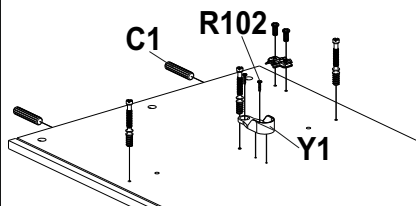
**103****104**

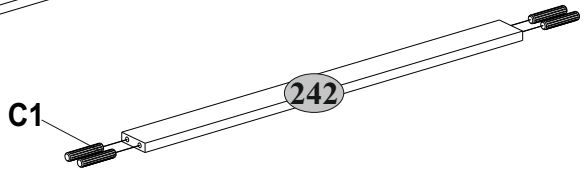
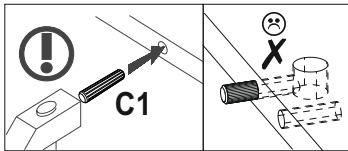
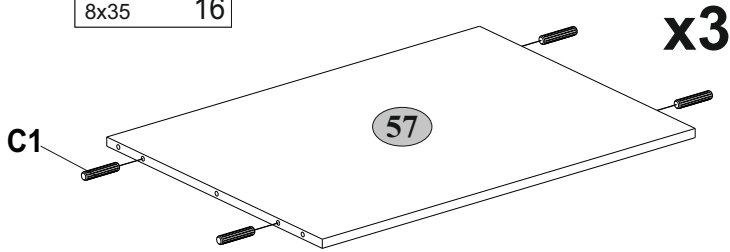
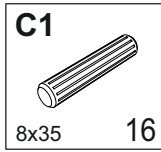

2

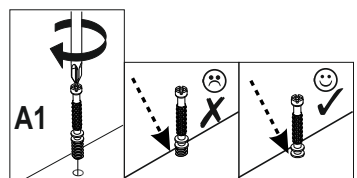
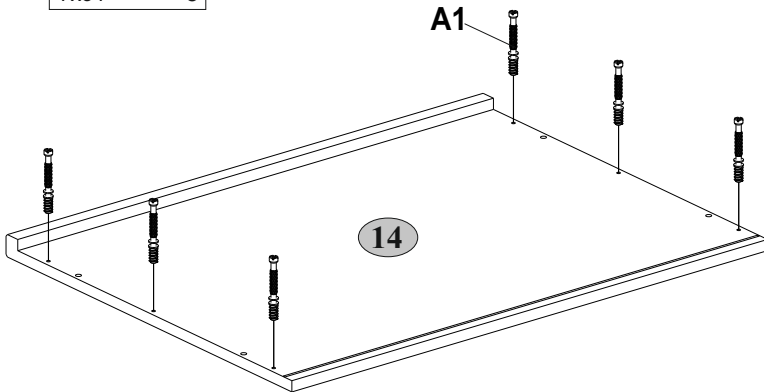
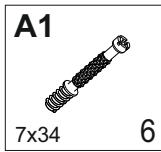

3



4

A2 	S5 
Ø15x12 18	Ø18 6

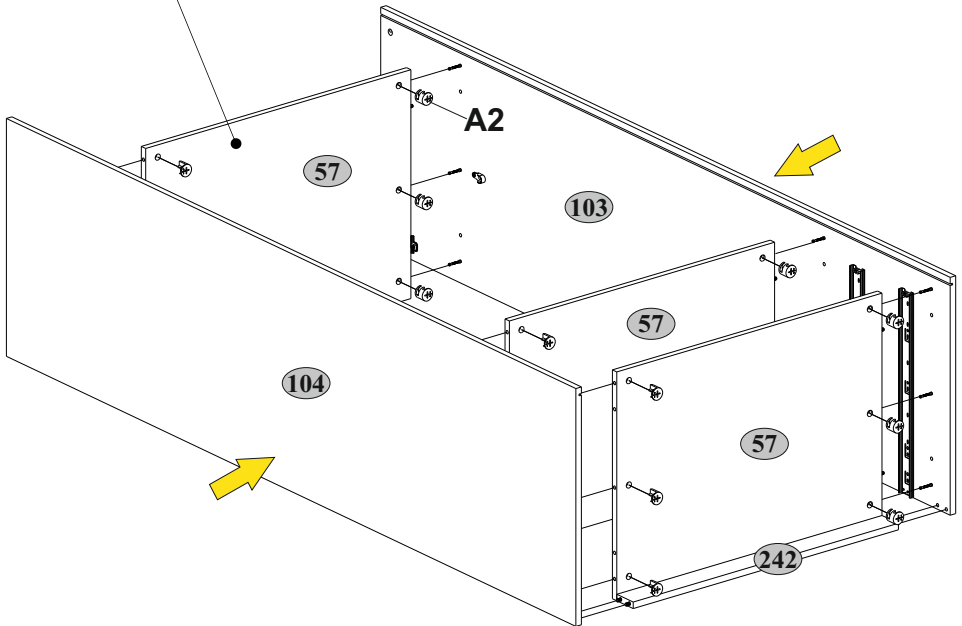
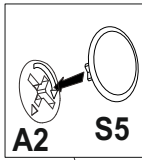
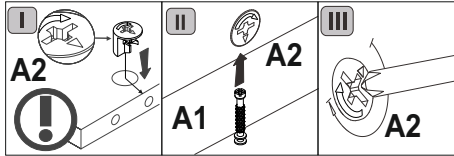

5

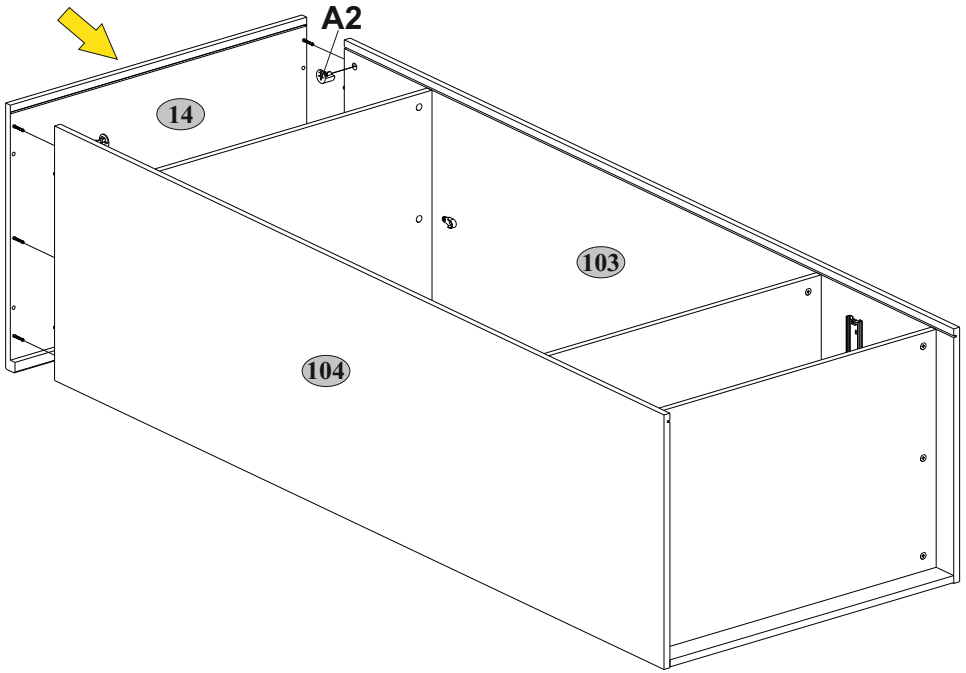
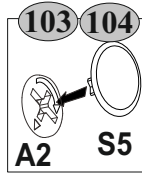
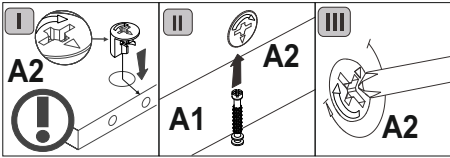
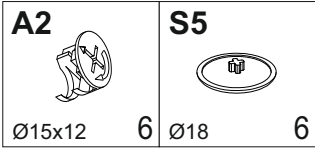



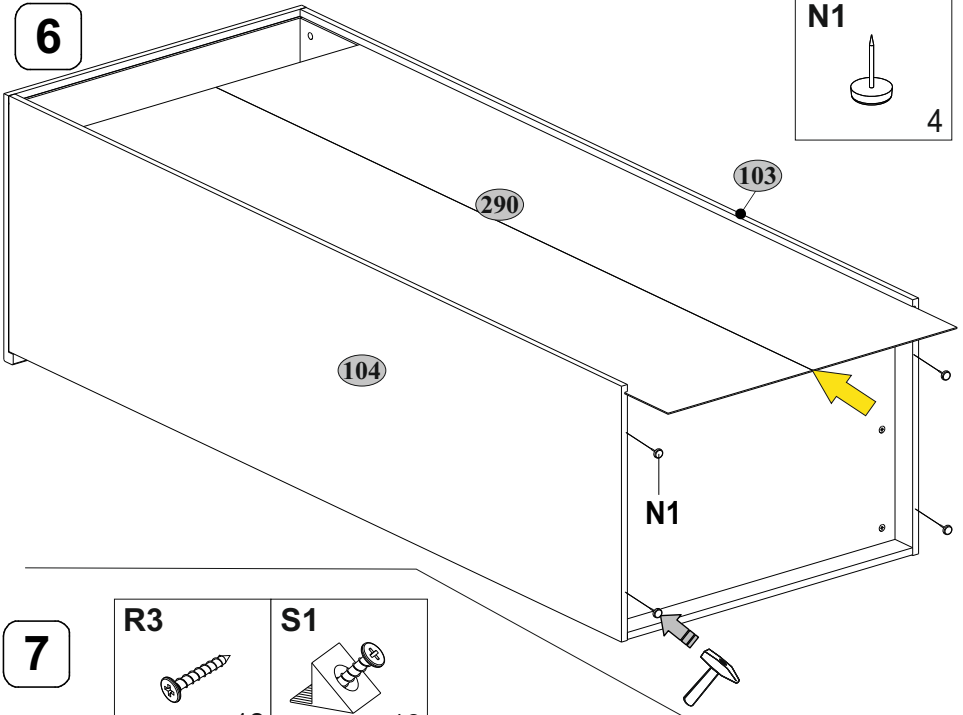
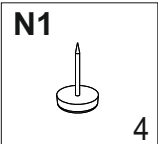



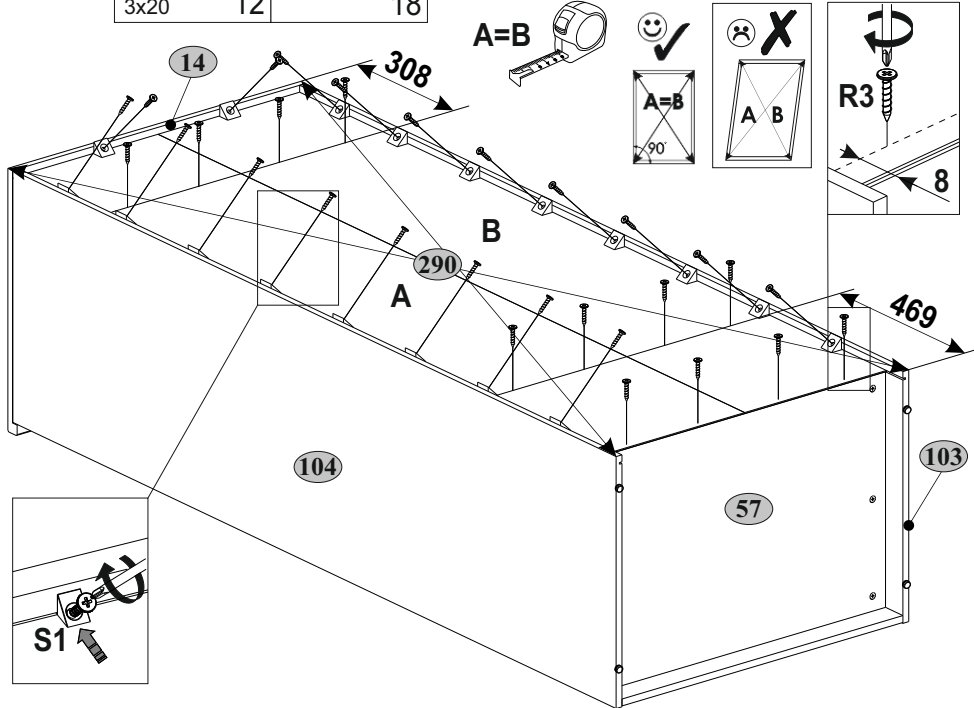
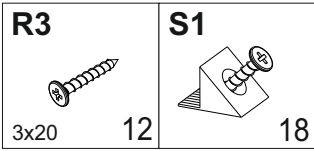

6

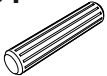

7



8

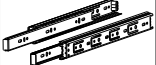

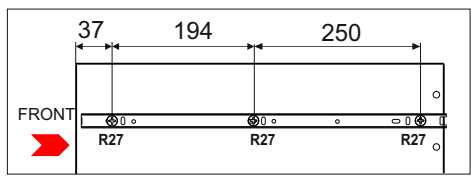
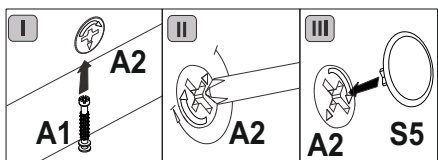
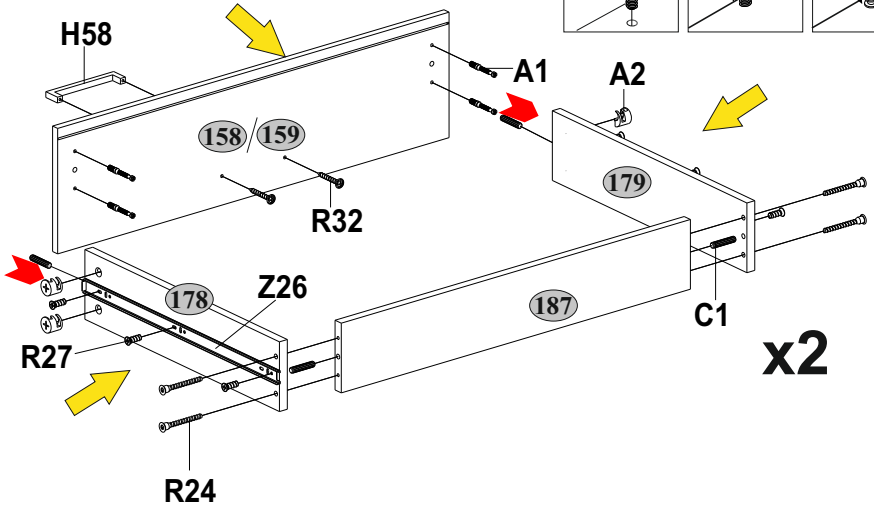
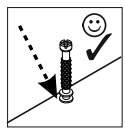
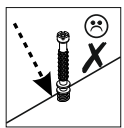
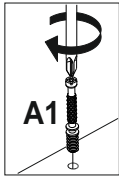
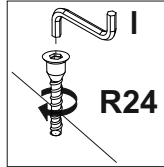
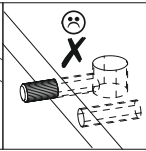
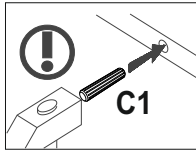
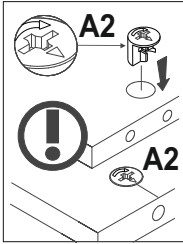
A1  7x34 8	A2  Ø15x12 8	C1  8x35 8	H58  2	I  S4 1
R27  5,0x13 12	R24  7x50 8	R32  4x27 4	S5  Ø18 8	Z26  500 2

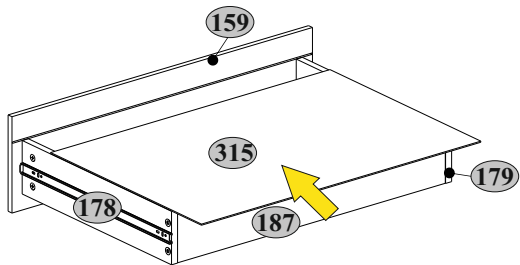
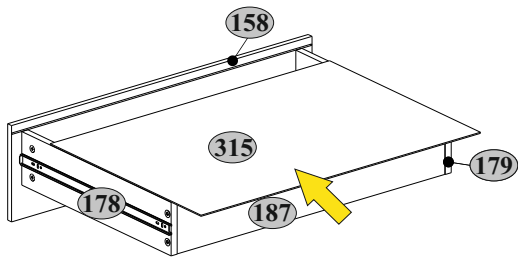

9



10

L2	R3	R102
		
500 2	3x20 16	3,5x16 4

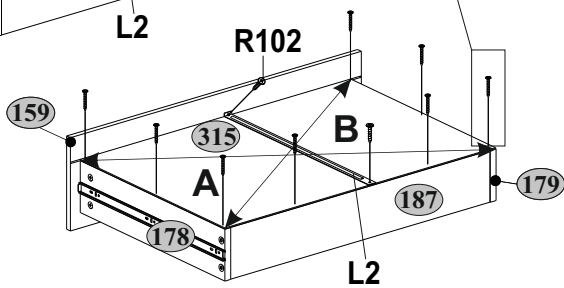
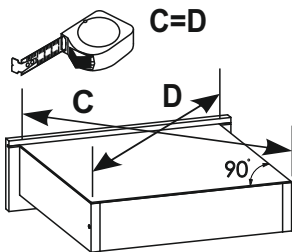
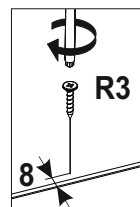
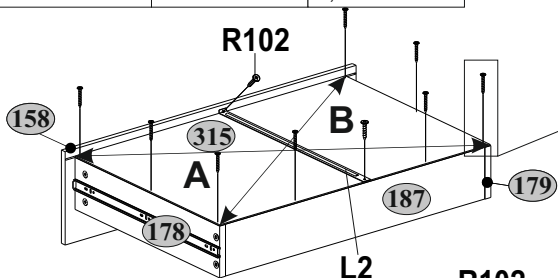

11

B5



10x50

1

R102



3,5x16

2

U





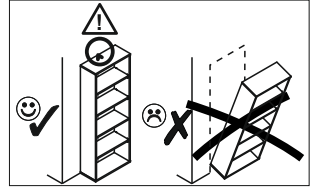
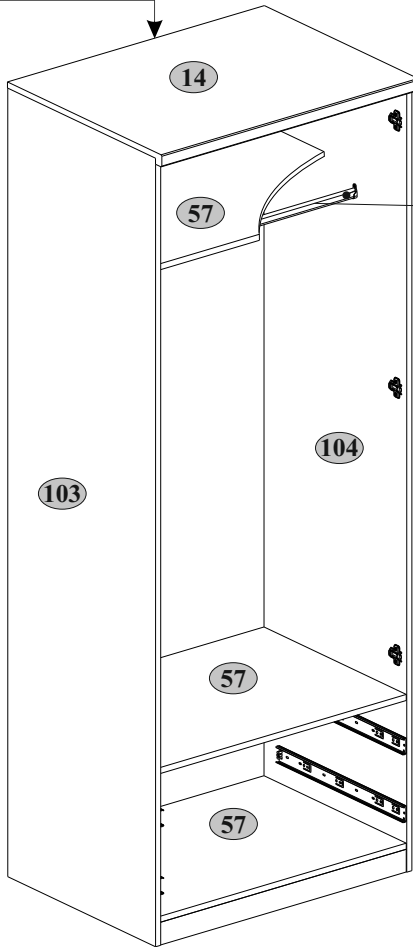
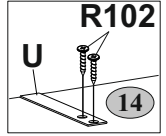
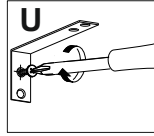
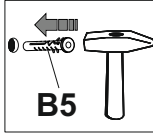
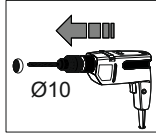
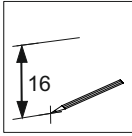
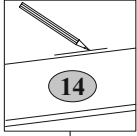

130x35x15

1

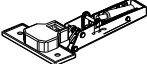

Y2 57 14  max. 10 kg

12

E1-1  6	H58  2	R32  4x27 4	R102  3,5x16 12
---	--	--	--

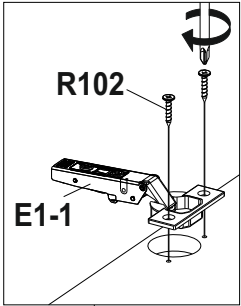

E1-1+D1-1

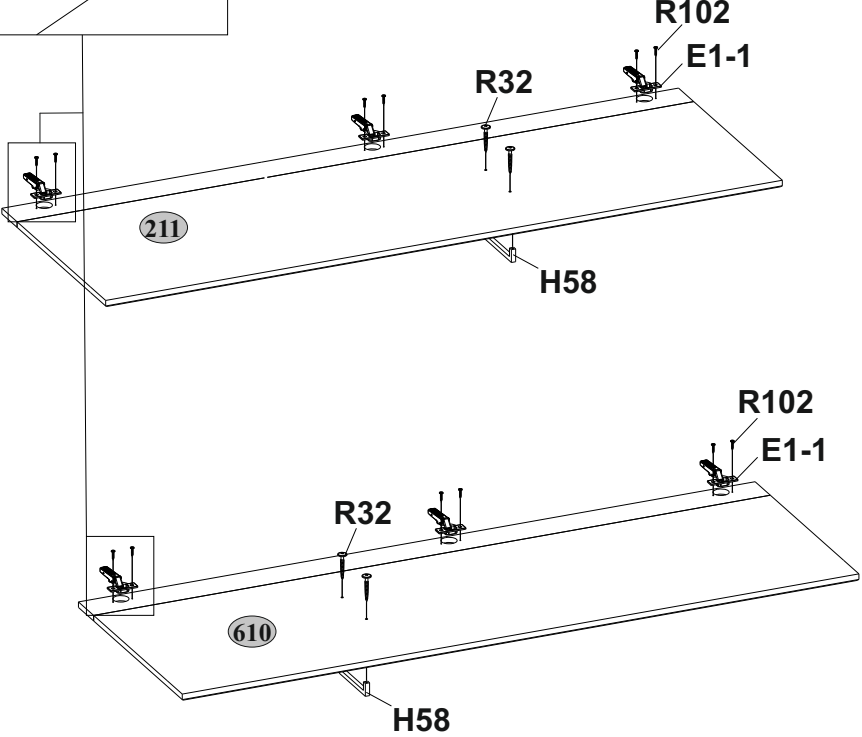
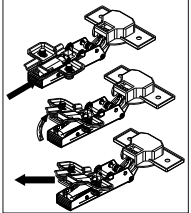

13

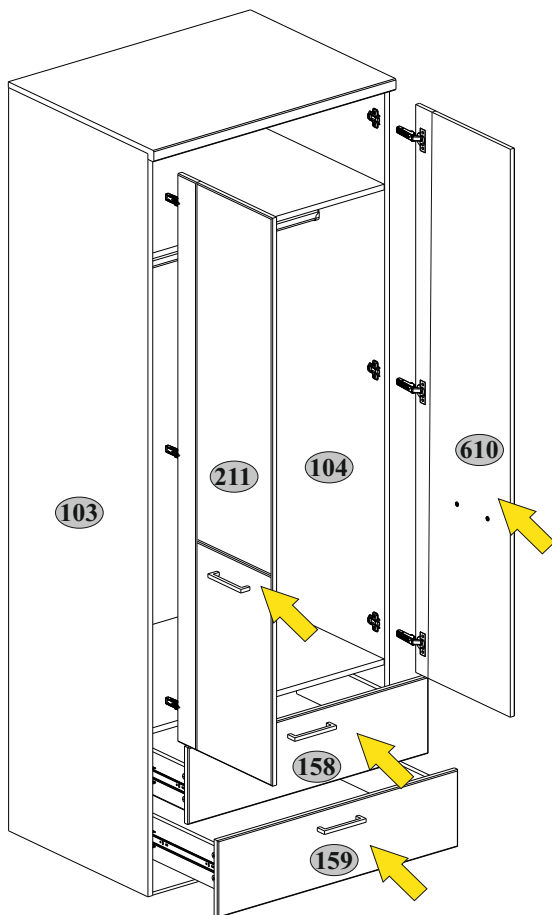
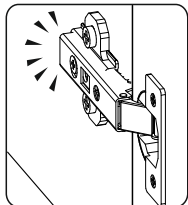
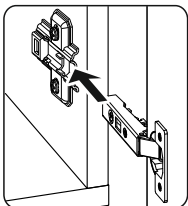

(158) (159)  max. 5 kg

